

Chapter 19: Real-Time Systems





Chapter 19: Real-Time Systems

- System Characteristics
- Features of Real-Time Systems
- Implementing Real-Time Operating Systems
- Real-Time CPU Scheduling
- An Example: VxWorks 5.x





Objectives

- To explain the timing requirements of real-time systems
- To distinguish between hard and soft real-time systems
- To discuss the defining characteristics of real-time systems
- To describe scheduling algorithms for hard real-time systems





Overview of Real-Time Systems

- A **real-time system** requires that results be produced within a specified deadline period.
- An **embedded system** is a computing device that is part of a larger system (i.e., automobile, airliner).
- A **safety-critical system** is a real-time system with catastrophic results in case of failure.
- A hard real-time system guarantees that real-time tasks be completed within their required deadlines.
- A **soft real-time system** provides priority of real-time tasks over non real-time tasks.





System Characteristics

- Single purpose
- Small size
- Inexpensively mass-produced
- Specific timing requirements





System-on-a-Chip

- Many real-time systems are designed using system-on-a-chip (SOC) strategy.
- SOC allows the CPU, memory, memory-management unit, and attached peripheral ports (I.e. USB) to be contained in a single integrated circuit.





Bus-Oriented System

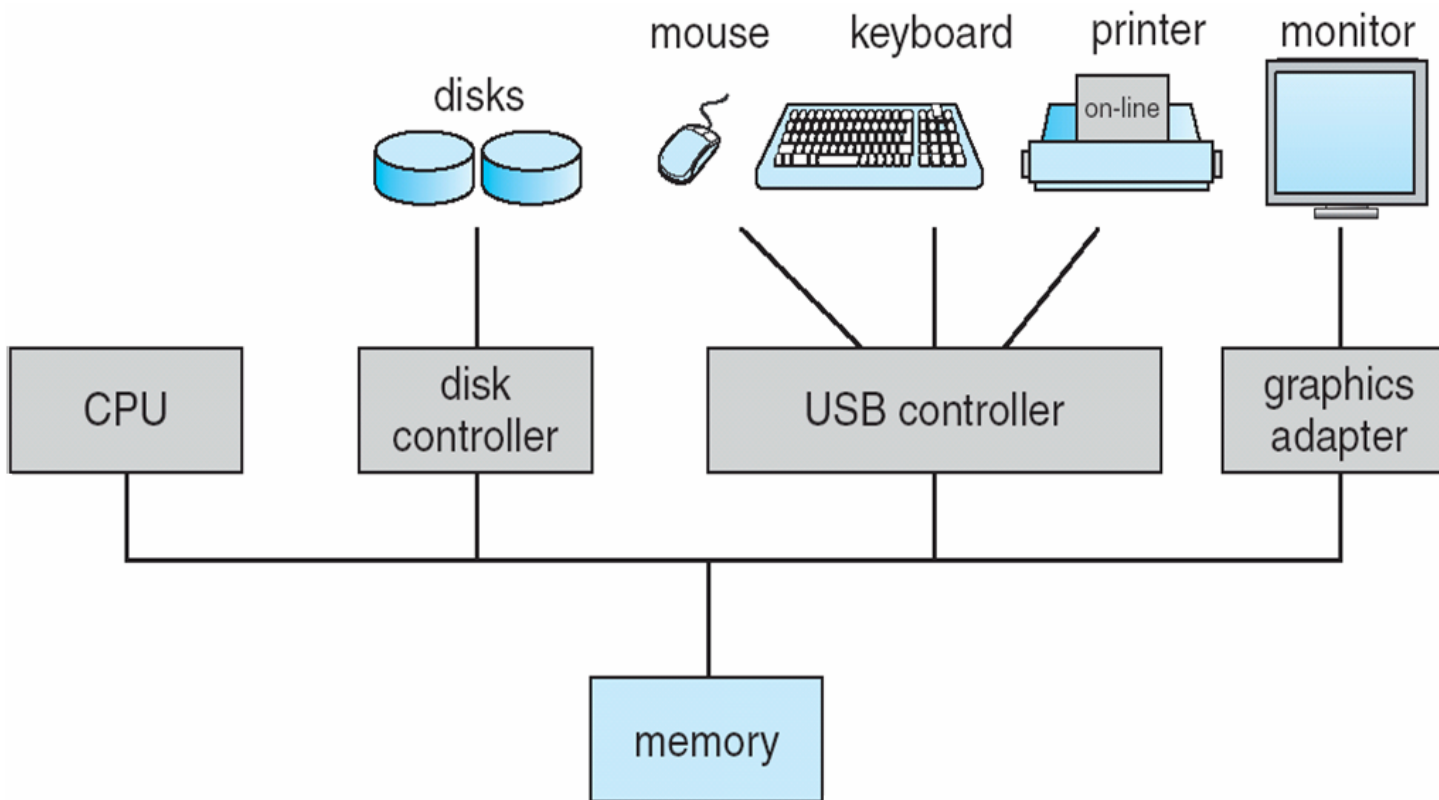



Features of Real-Time Kernels

- Most real-time systems do not provide the features found in a standard desktop system.
- Reasons include:
 - Real-time systems are typically single-purpose.
 - Real-time systems often do not require interfacing with a user.
 - Features found in a desktop PC require more substantial hardware than what is typically available in a real-time system.





Virtual Memory in Real-Time Systems

- Address translation may occur via:
 - (1) **Real-addressing mode** where programs generate actual addresses
 - (2) **Relocation** register mode
 - (3) Implementing full **virtual memory**





Address Translation

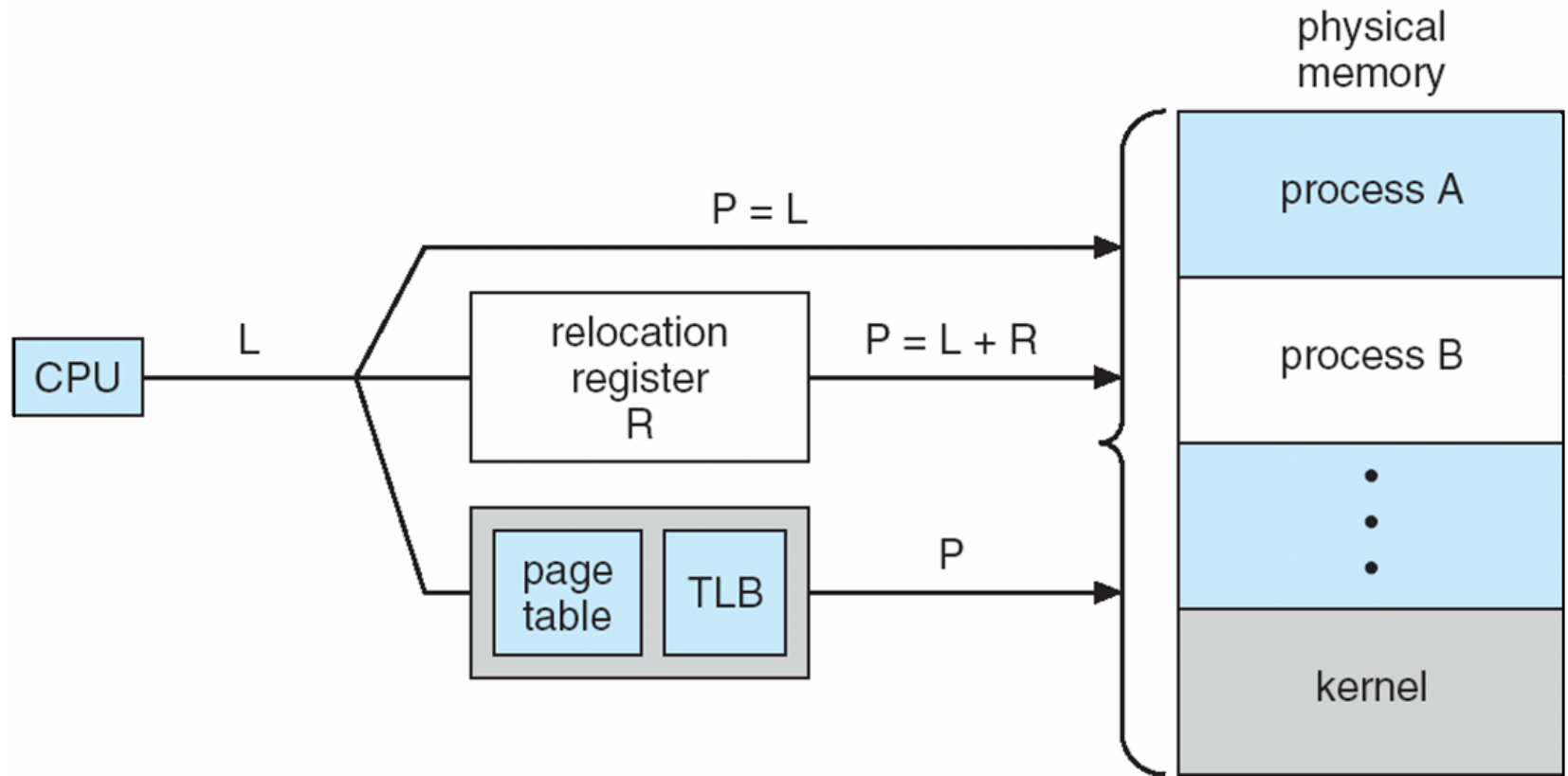



Implementing Real-Time Systems

- In general, real-time operating systems must provide:
 - (1) Preemptive, priority-based scheduling
 - (2) Preemptive kernels
 - (3) Latency must be minimized





Minimizing Latency

- **Event latency** is the amount of time from when an event occurs to when it is serviced.

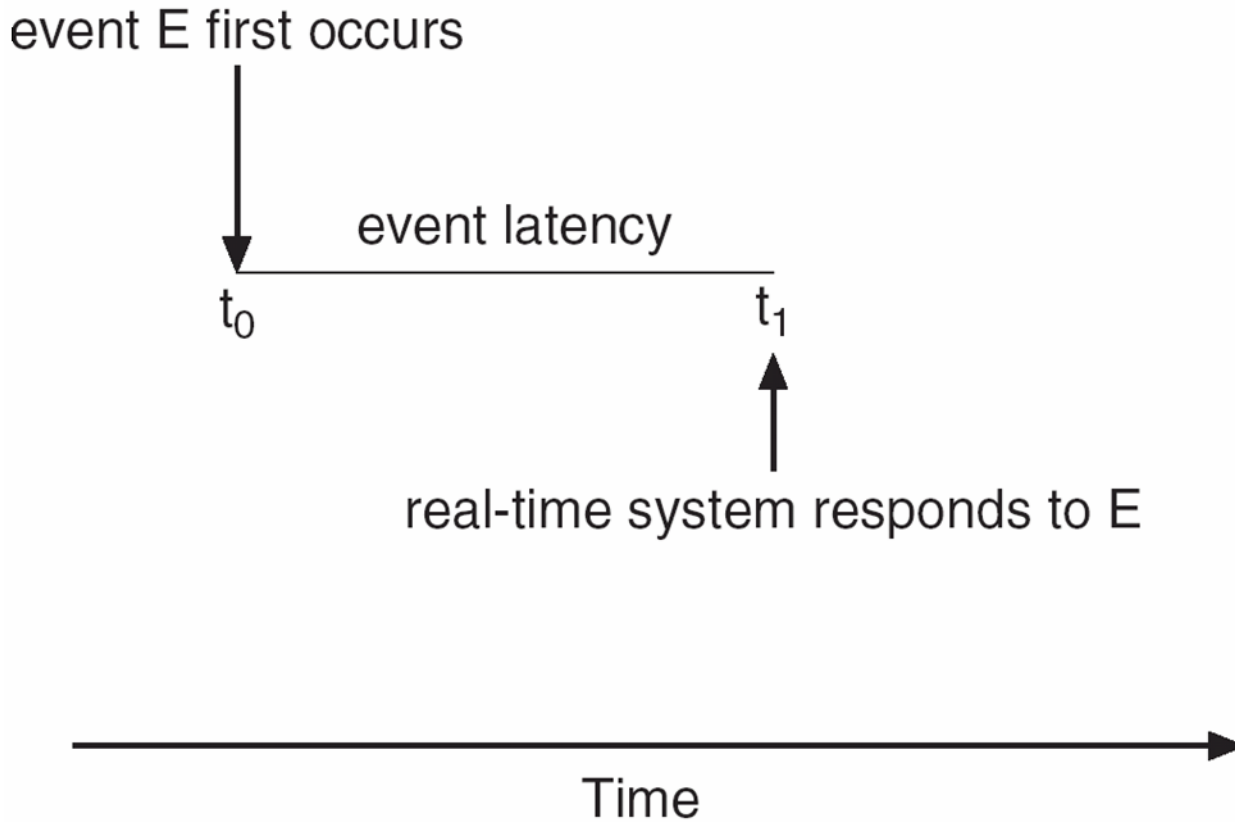



Interrupt Latency

- Interrupt latency is the period of time from when an interrupt arrives at the CPU to when it is serviced.

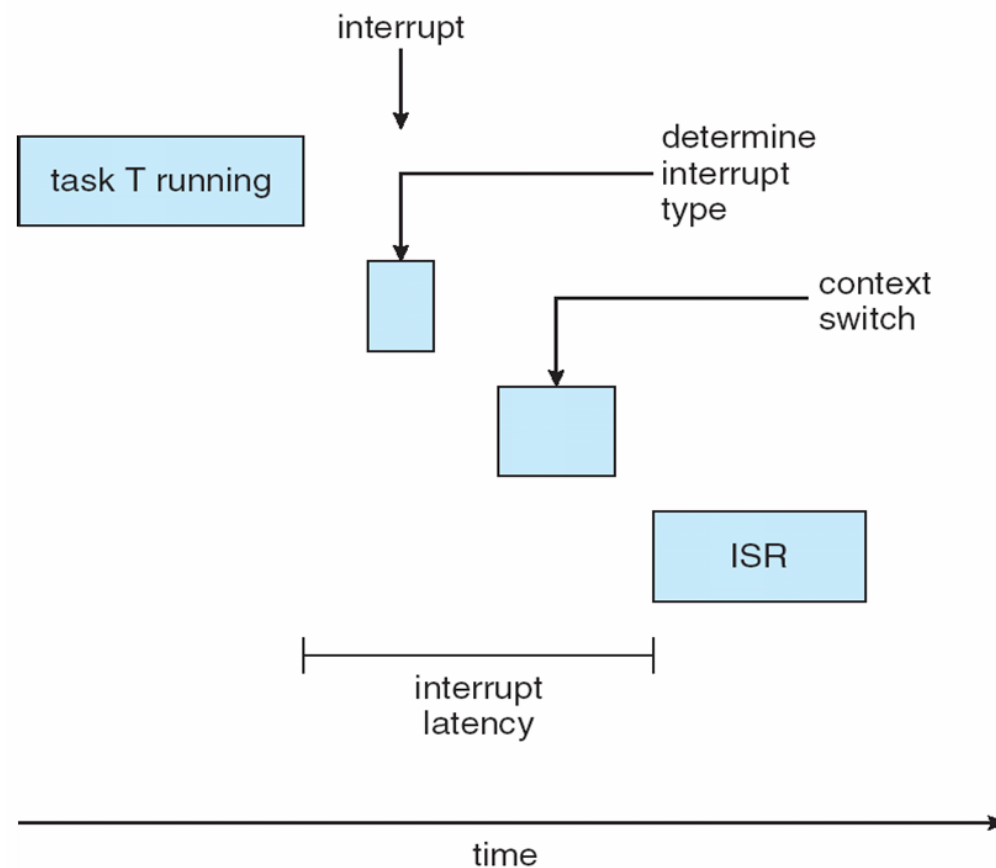



Dispatch Latency

- **Dispatch latency** is the amount of time required for the scheduler to stop one process and start another.

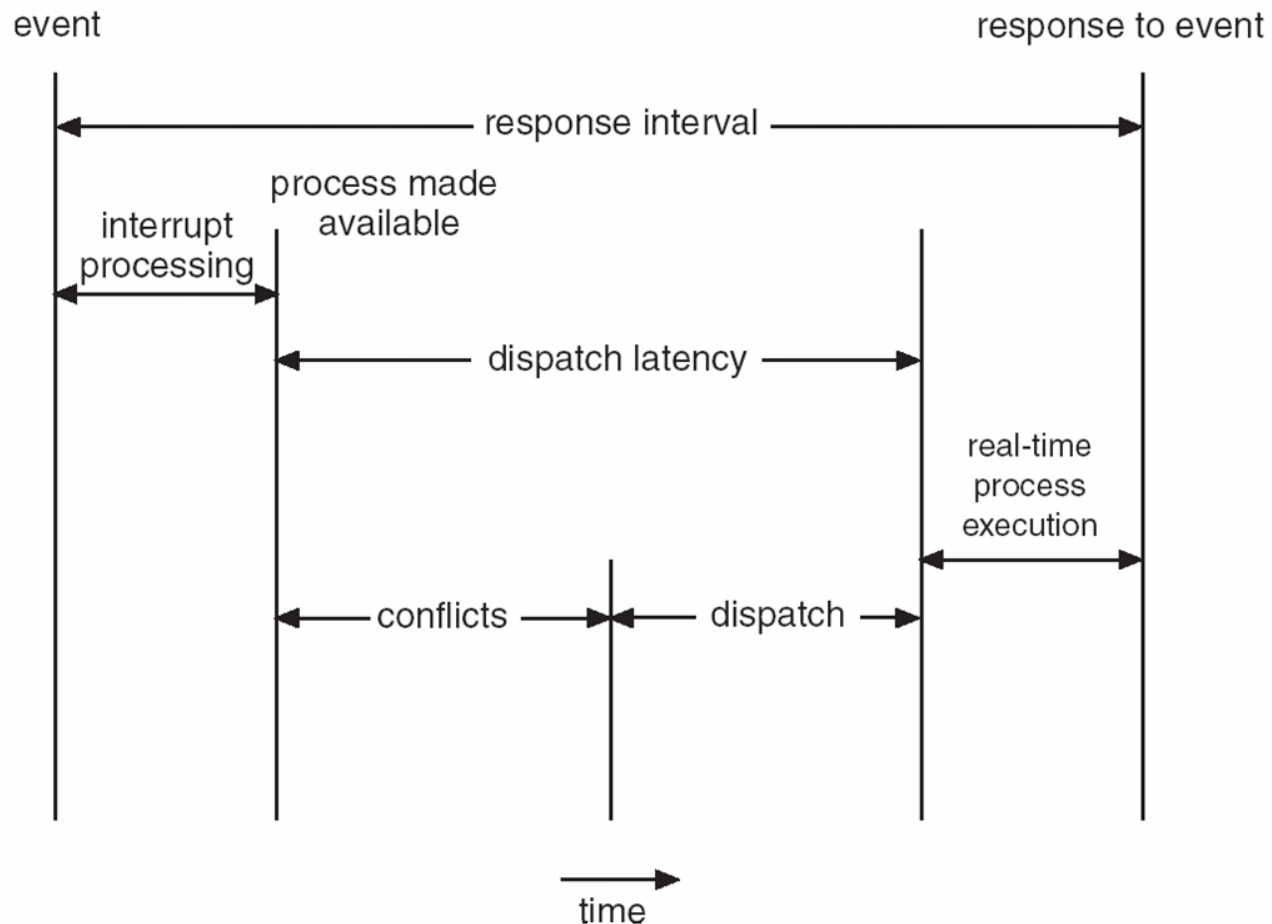



Real-Time CPU Scheduling

- Periodic processes require the CPU at specified intervals (periods)
- p is the duration of the period
- d is the deadline by when the process must be serviced
- t is the processing time

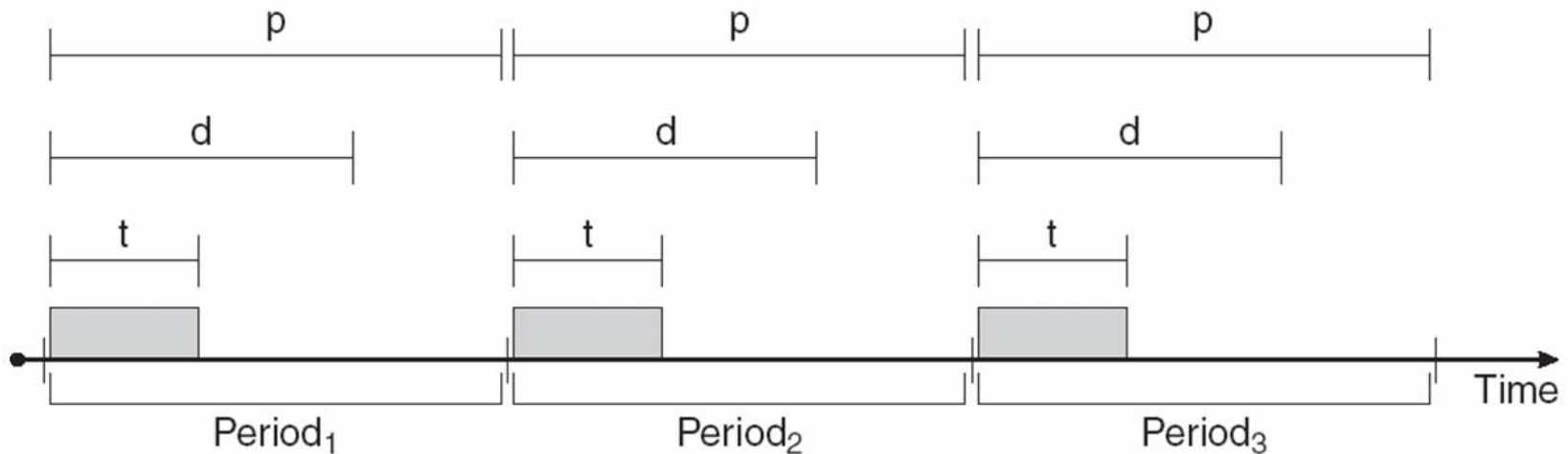



Scheduling of tasks when P_2 has a higher priority than P_1

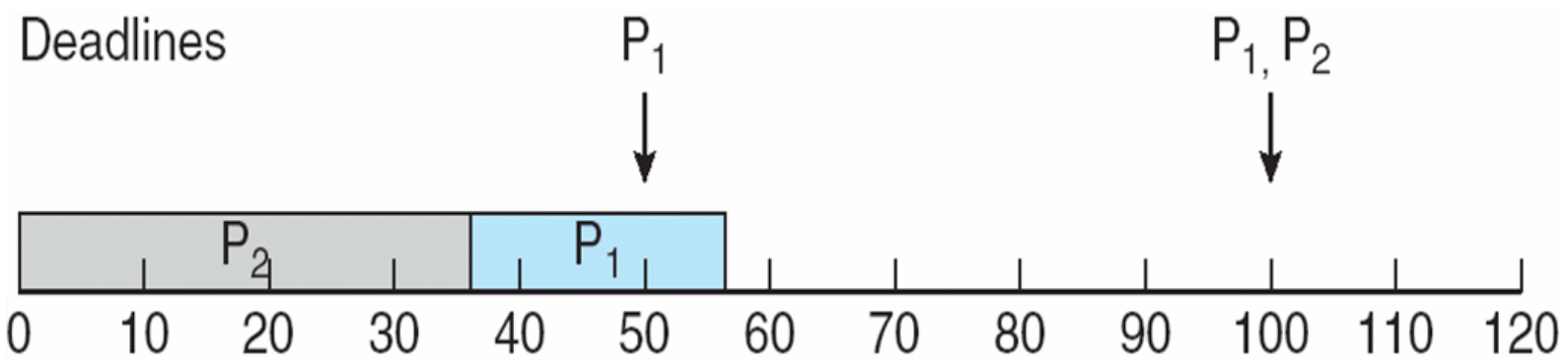



Rate Monotonic Scheduling

- A priority is assigned based on the inverse of its period
- Shorter periods = higher priority
- Longer periods = lower priority
- P_1 is assigned a higher priority than P_2 .

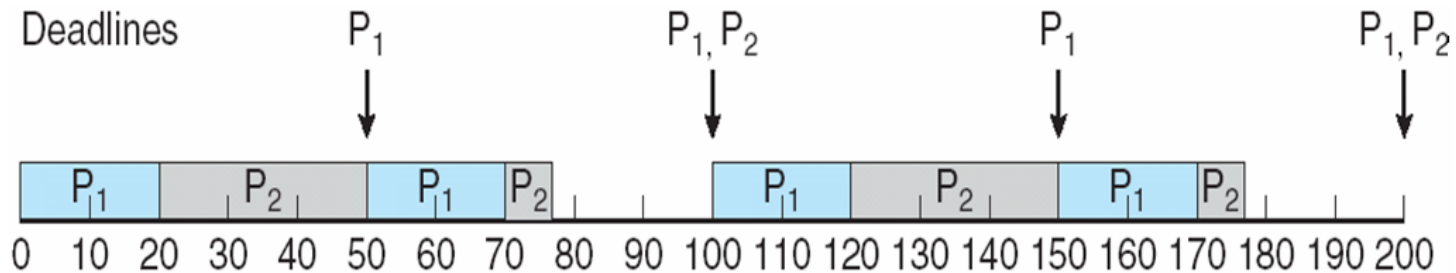



Missed Deadlines with Rate Monotonic Scheduling

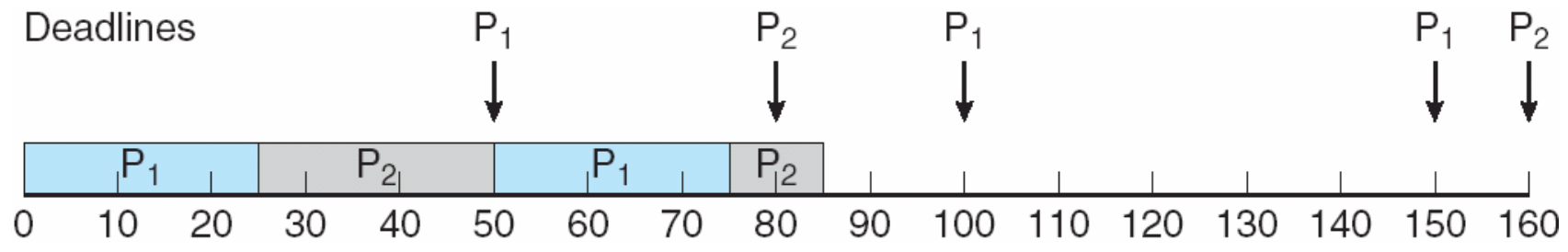



Earliest Deadline First Scheduling

- Priorities are assigned according to deadlines:
the earlier the deadline, the higher the priority;
the later the deadline, the lower the priority

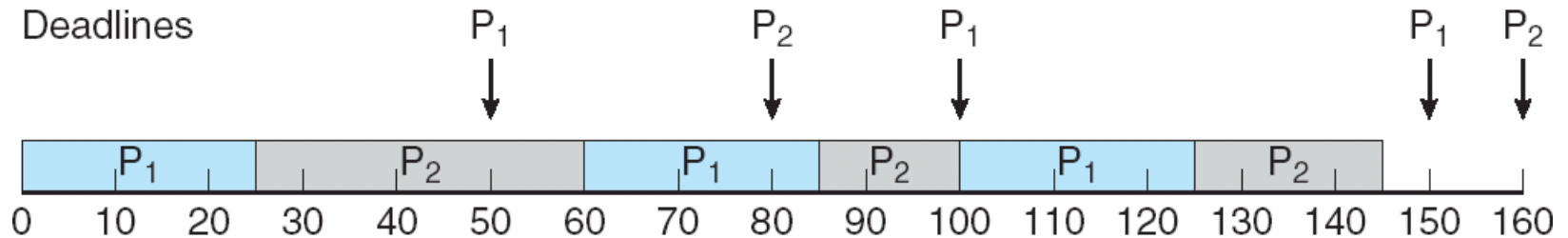



Proportional Share Scheduling

- T shares are allocated among all processes in the system
- An application receives N shares where $N < T$
- This ensures each application will receive N/T of the total processor time





Pthread Scheduling

- The Pthread API provides functions for managing real-time threads
- Pthreads defines two scheduling classes for real-time threads:
 - (1) SCHED_FIFO - threads are scheduled using a FCFS strategy with a FIFO queue. There is no time-slicing for threads of equal priority
 - (2) SCHED_RR - similar to SCHED_FIFO except time-slicing occurs for threads of equal priority





VxWorks 5.0

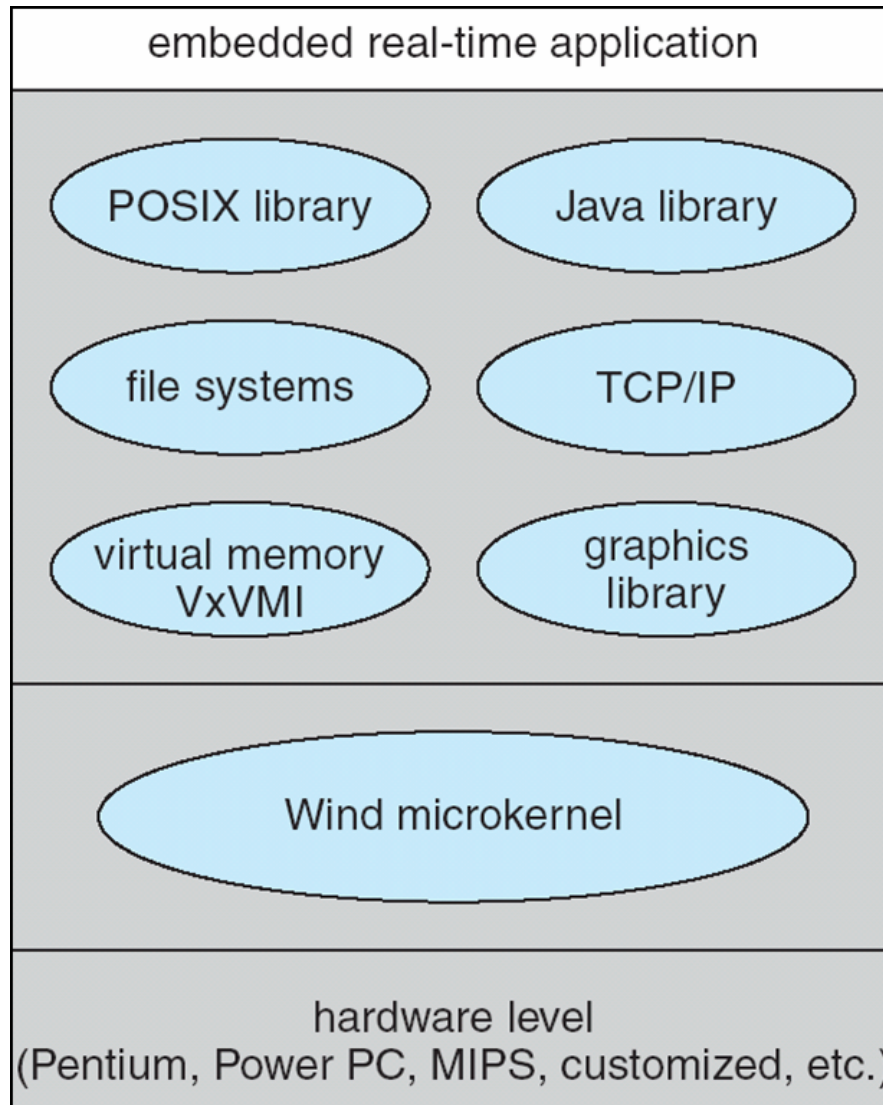



Wind Microkernel

- The Wind microkernel provides support for the following:
 - (1) Processes and threads
 - (2) preemptive and non-preemptive round-robin scheduling
 - (3) Manages interrupts (with bounded interrupt and dispatch latency times)
 - (4) Shared memory and message passing interprocess communication facilities



End of Chapter 19

